

# JBC

[www.jbctools.com](http://www.jbctools.com)

## INSTRUCTION MANUAL



### ALE

Automatic-Feed Soldering Control Unit

This manual corresponds to the following references:

**With** Solder Wire Perforation:

for wire $\varnothing$ 0.8 mm	for wire $\varnothing$ 1.0 mm	for wire $\varnothing$ 1.2 mm
<b>ALE-908UVA</b> (100 V) <b>ALE-108UVA</b> (120 V) <b>ALE-208UVA</b> (230 V)	<b>ALE-910UVA</b> (100 V) <b>ALE-110UVA</b> (120 V) <b>ALE-210UVA</b> (230 V)	<b>ALE-912UVA</b> (100 V) <b>ALE-112UVA</b> (120 V) <b>ALE-212UVA</b> (230 V)
for wire $\varnothing$ 1.5 mm	for wire $\varnothing$ 1.6 mm	
<b>ALE-915UVA</b> (100 V) <b>ALE-115UVA</b> (120 V) <b>ALE-215UVA</b> (230 V)	<b>ALE-916UVA</b> (100 V) <b>ALE-116UVA</b> (120 V) <b>ALE-216UVA</b> (230 V)	

**Without** Solder Wire Perforation:

for wire $\varnothing$ 0.38 - 0.4 mm	for wire $\varnothing$ 0.45 - 0.56 mm	for wire $\varnothing$ 0.60 - 0.64 mm
<b>ALE-904UA</b> (100 V) <b>ALE-104UA</b> (120 V) <b>ALE-204UA</b> (230 V)	<b>ALE-905UA</b> (100 V) <b>ALE-105UA</b> (120 V) <b>ALE-205UA</b> (230 V)	<b>ALE-906UA</b> (100 V) <b>ALE-106UA</b> (120 V) <b>ALE-206UA</b> (230 V)
for wire $\varnothing$ 0.70 - 0.78 mm	for wire $\varnothing$ 0.80 - 0.82 mm	for wire $\varnothing$ 0.90 - 1.10 mm
<b>ALE-907UA</b> (100 V) <b>ALE-107UA</b> (120 V) <b>ALE-207UA</b> (230 V)	<b>ALE-908UA</b> (100 V) <b>ALE-108UA</b> (120 V) <b>ALE-208UA</b> (230 V)	<b>ALE-910UA</b> (100 V) <b>ALE-110UA</b> (120 V) <b>ALE-210UA</b> (230 V)
for wire $\varnothing$ 1.14 - 1.27 mm	for wire $\varnothing$ 1.50 - 1.57 mm	for wire $\varnothing$ 1.60 - 1.63 mm
<b>ALE-912UA</b> (100 V) <b>ALE-112UA</b> (120 V) <b>ALE-212UA</b> (230 V)	<b>ALE-915UA</b> (100 V) <b>ALE-115UA</b> (120 V) <b>ALE-215UA</b> (230 V)	<b>ALE-916UA</b> (100 V) <b>ALE-116UA</b> (120 V) <b>ALE-216UA</b> (230 V)
for wire $\varnothing$ 1.80 mm		
<b>ALE-918UA</b> (100 V) <b>ALE-118UA</b> (120 V) <b>ALE-218UA</b> (230 V)		

**Note:** For correct operation, the diameter of the solder wire in use must match the diameter of the ALE reference purchased.

## Packing List

The following items are included in **all references**:



**Automatic-Feed Soldering Control Unit** ..... 1 unit

**Power Cord** ..... 1 unit  
Ref. 0023717 (120V)  
0024080 (230V)

**Manual** ..... 1 unit  
Ref. 0030217

**Key Set\***  
**for SF / AL** ..... 1 unit  
Ref. 0019341

includes:



**Spanner** ..... 1 unit



**Allen Key ø 1.5** ..... 1 unit



**Allen Key ø 2.5** ..... 1 unit

*\*already assembled in ALE Control Unit*

# Packing List

One of the following items is included **according to purchased reference:**



**Solder Wire Guide Kit** ..... 1 unit

**With** solder wire perforation:

for wire  $\varnothing$  0.8 mm /  $\varnothing$  0.032 in \_\_\_\_\_

- Ref. **GALE08V-A**

for wire  $\varnothing$  1.0 mm /  $\varnothing$  0.040 in \_\_\_\_\_

- Ref. **GALE10V-A**

for wire  $\varnothing$  1.2 mm /  $\varnothing$  0.047 in \_\_\_\_\_

- Ref. **GALE12V-A**

for wire  $\varnothing$  1.6 mm /  $\varnothing$  0.063 in \_\_\_\_\_

- Ref. **GALE16V-A**

**Without** solder wire perforation:

for wire  $\varnothing$  0.38 - 0.4 mm /  $\varnothing$  0.015 - 0.016 in \_\_\_\_\_

- Ref. **GALE04D-A**

for wire  $\varnothing$  0.46 - 0.56 mm /  $\varnothing$  0.018 - 0.022 in \_\_\_\_\_

- Ref. **GALE05D-A**

for wire  $\varnothing$  0.80 - 0.82 mm /  $\varnothing$  0.032 - 0.033 in \_\_\_\_\_

- Ref. **GALE08D-A**

for wire  $\varnothing$  0.90 - 1.10 mm /  $\varnothing$  0.036 - 0.044 in \_\_\_\_\_

- Ref. **GALE10D-A**

**Note:** For correct operation, the diameter of the solder wire in use must match the diameter of the purchased guide kit.

Guide sets for different diameters are available at:  
[www.jbctools.com/solder-wire-guide-kit-product-2098.html](http://www.jbctools.com/solder-wire-guide-kit-product-2098.html)



## Features and Connections



Solder Reel Stand

Display

USB-A Connector

Main Switch

**ALE**  
Automatic-Feed  
Soldering Control Unit

**ALE250**  
Automatic-Feed  
Soldering Iron\*

**SOLDER WIRE GUIDE**

Kit for ALE250  
available for  
different solder  
wire diameters  
see page 11 + 12

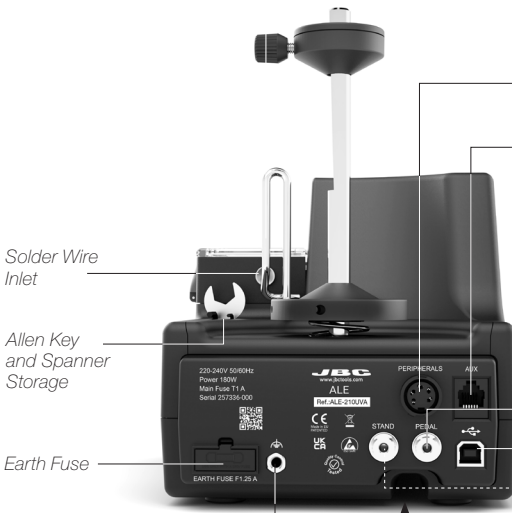

Solder Wire Inlet

Allen Key and Spanner Storage

Earth Fuse

Equipotential Connector

Power Socket and Main Fuse

Peripherals Connector

RJ12 Connector for FAE and Robot System

Pedal Connector

USB-B Connector

below

**ALES**  
Stand for ALE250  
Automatic-Feed  
Soldering Iron\*



\*not included

# Cartridge Assembly

⚠ For a safe cartridge assembly/change, make sure that the tool is unplugged and that any cartridge in place has cooled down before following these guidelines:

Loosen the cartridge set screw (1), remove the used cartridge if there is any already in place, and insert the new cartridge up to its mark (2).

**Important:** It is essential to insert the cartridge completely for a good connection. Use the mark as reference (3).

Adjust the cartridge tip direction (4) and tighten the cartridge set screw (1).

## ALE250

Auto-Feed Soldering Iron

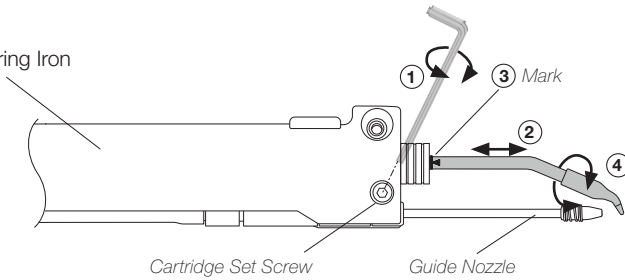

# Guide Tube Set Assembly

Open the guide tube set screw (1) and insert the guide tube set.

Adjust the guide tube length (2). Leave a gap of 5 to 7 mm (0.19 to 0.27 in) between the tip and the outlet nozzle (3). Once the position is adjusted tighten the guide tube set screw (1).

For a better handling use the clips (4) to attach the guide tube to the tool cable.

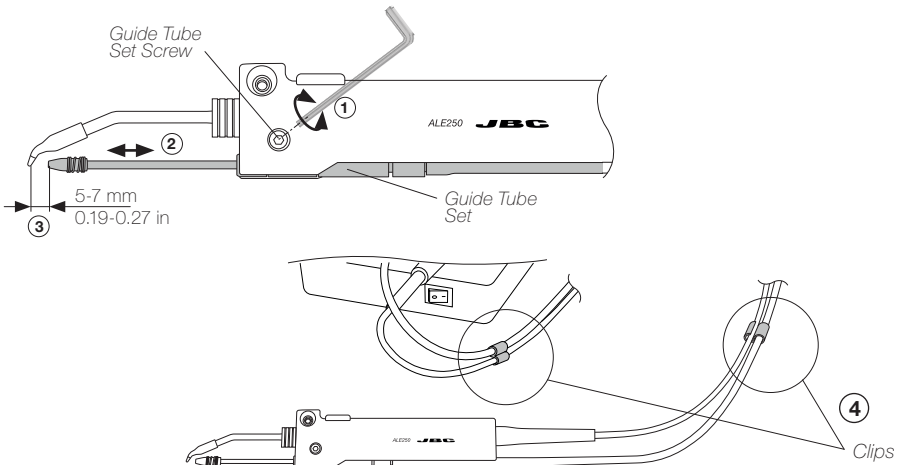

## Outlet Nozzle Replacement

Flux can cause clogging at the outlet nozzle of the guide tube set and it can be necessary to replace the worn or clogged outlet nozzle.

**Note:** There is a nozzle size for each soldering wire diameter. The use of the nozzle is necessary as its inner diameter is adjusted to the solder wire diameter and guides the wire with greater precision.

To replace the outlet nozzle, follow these steps:

First, make sure that the tool has cooled down and unload any remaining solder wire that might still be inside the guide tube (see pages 11 and 12). Unplug the tool. Loosen the guide tube set screw (1) and detach the guide tube set from the tool for easier handling.

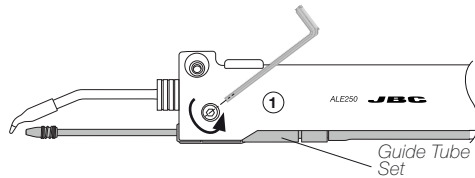

Unscrew the spring inwards (2), following the downward direction of the spring.

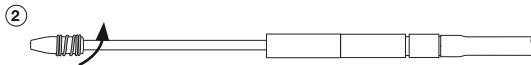

Once the outlet nozzle is released from the spring, pull the outlet nozzle out (3) and then remove the spring (4).

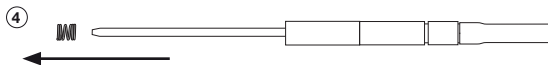
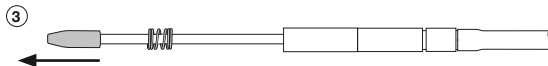

Place the new outlet nozzle onto the guide tube set (5).



Once the outlet nozzle is set in place, screw the spring onto it to fix the outlet nozzle onto the guide tube (6).

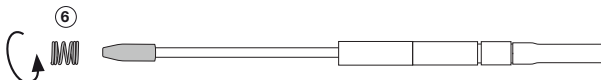

## Tool Assembly

Connect the tool to the control unit following these steps:

Loosen the set screw, insert and push the guide nozzle until it stops (1) and tighten the set screw (2) again. Then plug in the tool connector (3).

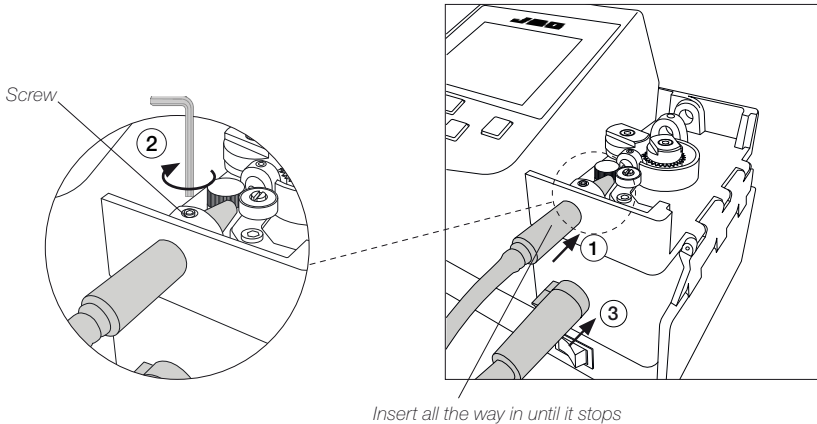

*Insert all the way in until it stops*

## Solder Reel Assembly

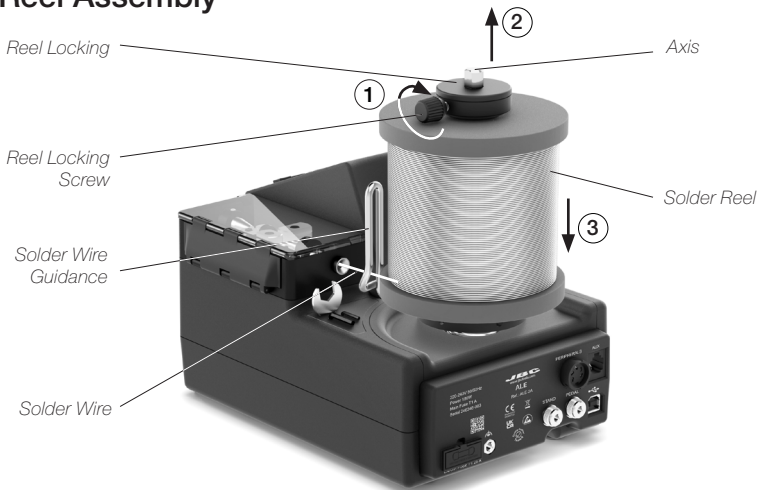

Loosen the reel locking screw (1) and remove the reel locking (2) from the axis.

Assemble the solder reel onto the axis (3).

Assemble the solder reel in such a way - when viewed from above - that the solder wire unwinds on the dispensing mechanism side (4). Then pass the solder wire through the wire guidance (5).

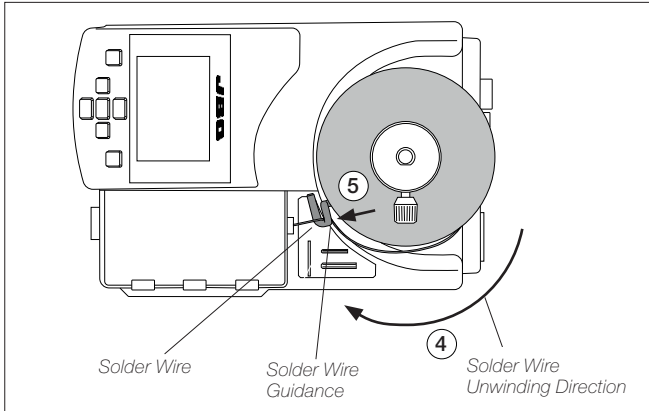

## Reel Locking Assembly

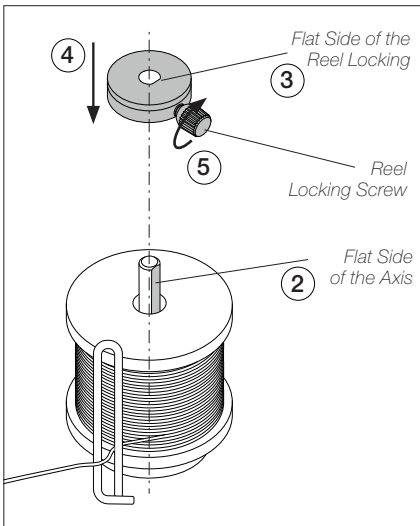

To assemble the reel locking, its conical side (1) must be pointing downwards.

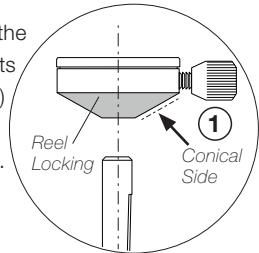

Reel Locking Top View

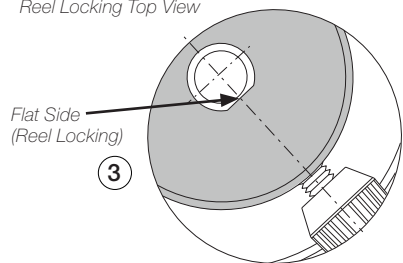

Align the flat side of the axis (2) with the inner flat side (the one with the screw) of the reel locking (3) and reassemble it to the axis (4).

**Note:** To prevent the solder reel from spinning freely or binding, before tightening the reel locking screw gently press the reel locking down, but only enough to allow the solder reel to rotate freely, before tightening the reel locking screw (5).

## Main Menu Screen

Access to Main Menu by pressing , select “Feeder settings” (1) and then “Wire diameter” (2) to adjust the value to the current solder wire diameter.

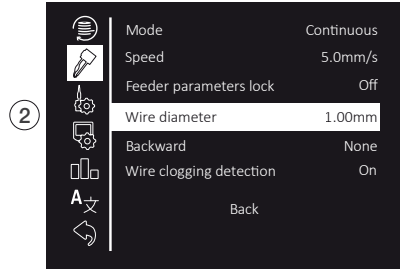
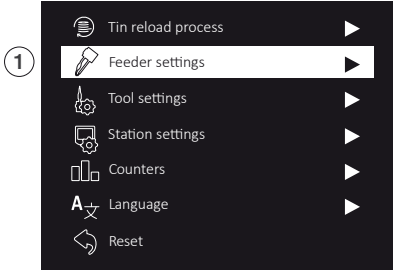

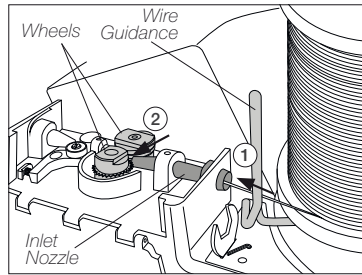

## Solder Wire Loading

Pass the solder wire through the wire guidance and introduce the solder wire into the inlet nozzle (1) until it reaches the wheels (2).

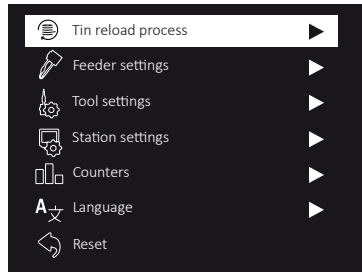

Select “Tin reload process” and then use  to feed the solder wire and advance until it comes out of the outlet nozzle.



If needed, carefully push the wire until it gets locked in between the rotating wheels for the wire to start moving forward. Keep  pressed and after a while, the wire will advance faster.

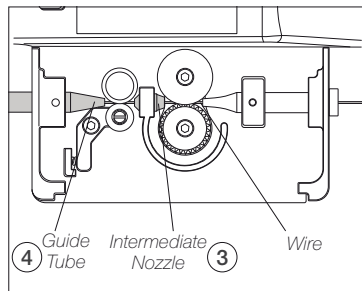

Make sure the wire passes through the intermediate nozzle (3) and enters the guide tube (4).

## Solder Wire Feeding

Forward the solder wire by pressing the dragging button (1) until the wire comes out of the tip (2).

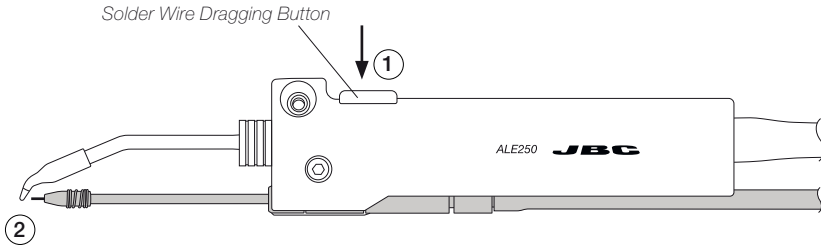

Alternatively, solder wire can also be fed using the pedal P405. The pedal should be plugged in at the rear of the feeder control unit into the pedal connector.



## Solder Wire Unloading

### With Solder Wire Perforation

To unload solder wire with perforation that has already passed through the guide tube, cut the wire between the wire guidance and the inlet nozzle (1).

To extract the wire out of the tube, hold the tool on your hand and press  until the wire stops moving forward.

Grasp the wire coming out of the outlet nozzle with a pliers and pull from it until it is completely out.

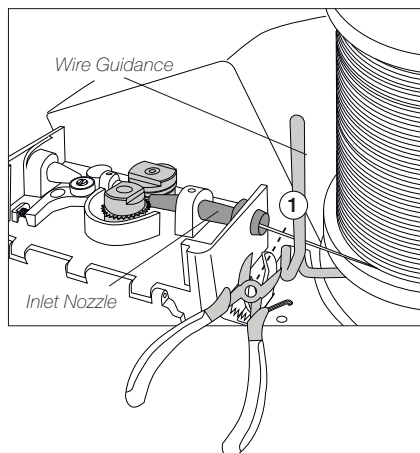

# Solder Wire Unloading

## Without Solder Wire Perforation

When using a kit without solder wire perforation, press  until the wire is completely wound to unload the solder wire. It is best to rotate the reel by hand as the wire is being pulled back in order to keep it neatly arranged on the reel.

Or, if preferred, proceed as described before for perforated solder wire unloading.

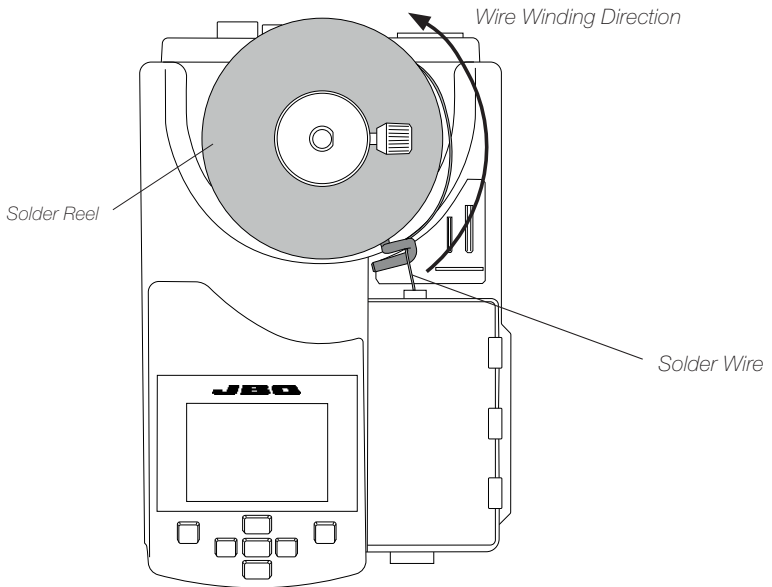



## Guide Kits Disassembly

For this operation, disconnect the device from the mains. Unload any solder wire running inside the guide tube, disconnect the tool from the control unit and open its cover.

Before trying to remove any components, be sure to loosen the corresponding set screws. To do this, use the Allen key and spanner provided with the station.

First disassemble the guide tube set (1), the guide wheel (4), blade and blade clamp (5) and then the nozzles (2) + (3). **Note:** The wheel components<sup>\*3</sup> on devices without solder wire perforation (10) are slightly different from those with solder wire perforation.

Lastly, disassemble the counter wheel (6), introducing the Allen key through the frontal opening (9) to loosen its set screw.

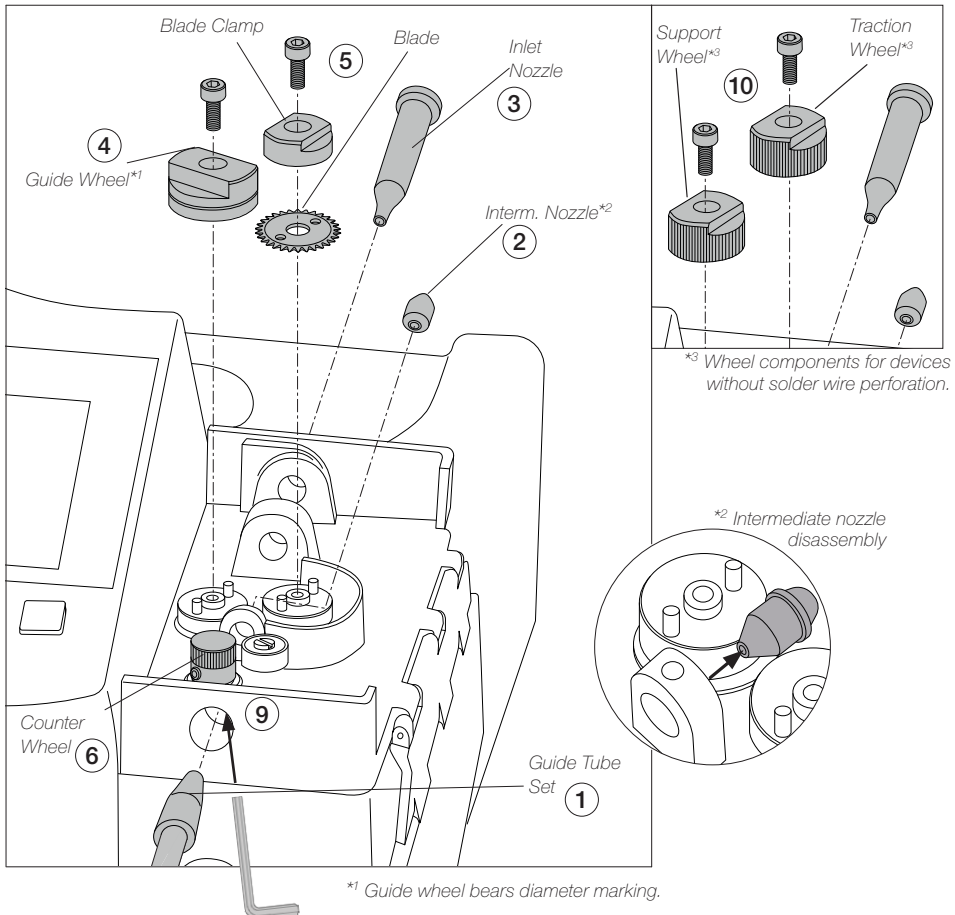

# Guide Kits Assembly - with Solder Wire Perforation:

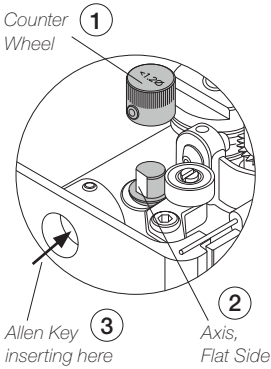

Assemble first the counter wheel (1). Make sure that its thread entry for the set screw is aligned with the flat side of the axis (2). If not, the set screw will protrude, which may cause difficulties for the wire transportation.

Inserting the Allen key through the front opening will make it easier to tighten the screw (3).

Afterwards Insert the intermediate nozzle (4) until its collar rests against the housing and tighten its screw.

Assemble the inlet nozzle (5).

Assemble the guide wheel (6) and tighten its screw.

Assemble the blade first (7), then mount the blade clamp (8) onto the same axis and tighten the screw.

**Caution:** handle the blade carefully to avoid injury.

Finally insert the guide tube set (9).

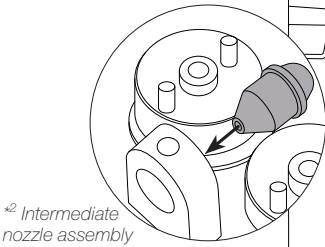
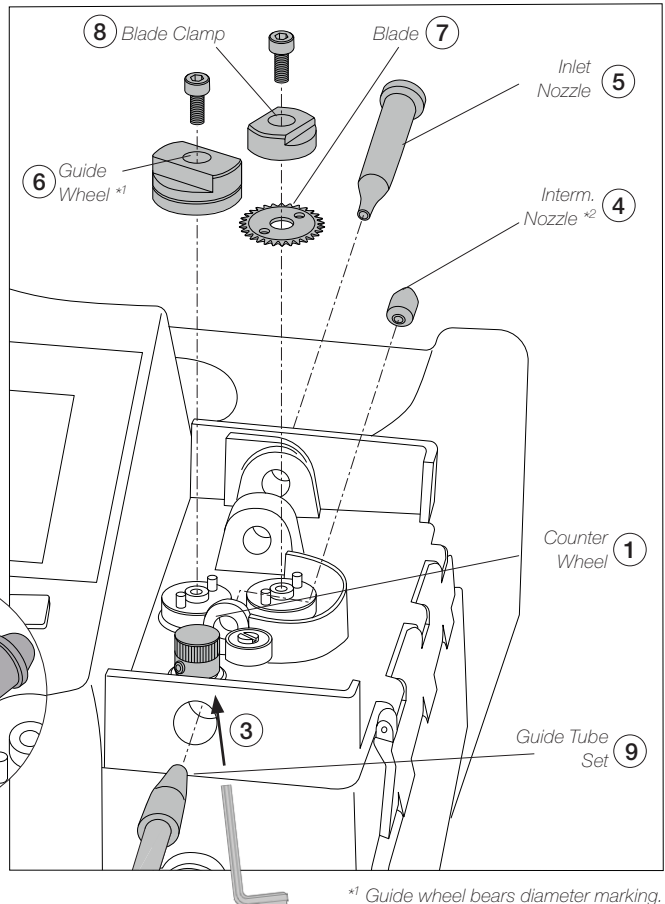

## Guide Kits Assembly - without Solder Wire Perforation:

Assemble first the counter wheel (1) in the same way as shown on the previous page (see (1), (2) and (3) on the page before).

Afterward as insert the intermediate nozzle (2) until its collar rests against the housing and tighten its screw.

Assemble the inlet nozzle (3).

Assemble the support wheel\* (4) and the traction wheel (5) on the corresponding axis and tighten the respective screws

Finally insert the guide tube set (6) and tighten the screw.

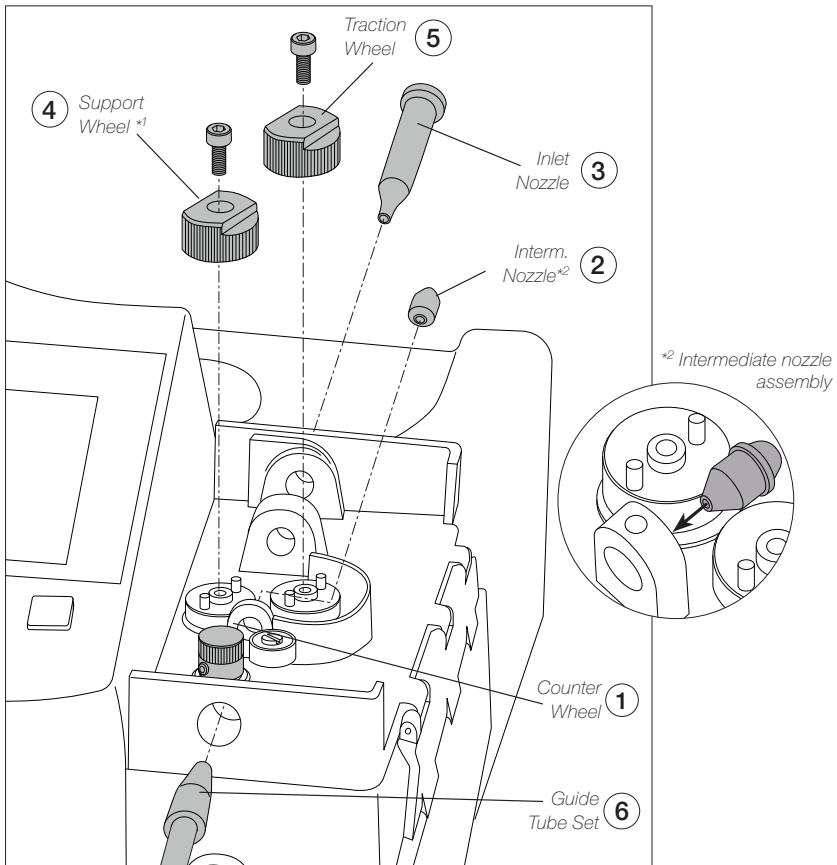

\*1 Support wheel bears diameter marking.

# Control Process

## Feeder Setting Modes

Access to Main Menu by pressing , select "Feeder Settings" and then "Mode". Choose between "continuous", "discontinuous" and "program" mode.

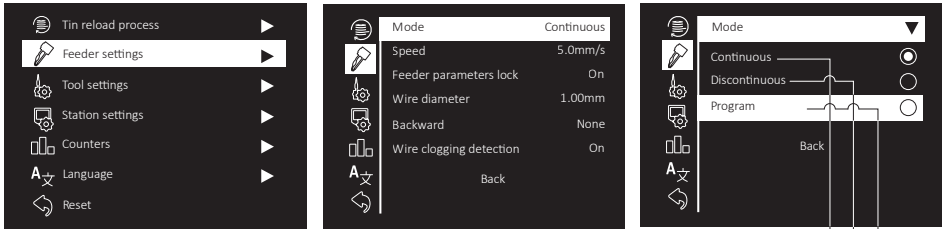

Depending on the selected mode, different parameters are available for setup.

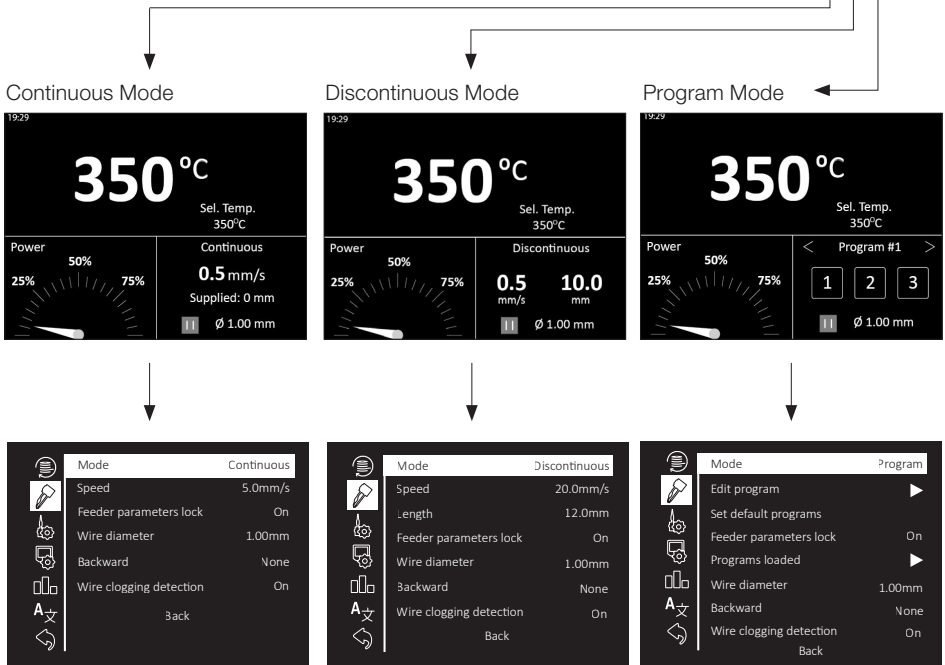

## Troubleshooting

Station troubleshooting available on the product page at [www.jbctools.com](http://www.jbctools.com)

## Control Process

### Program Mode

With ALE C.U. there can be up to 5 feeder programs defined. Select “Edit Program” and access the program parameters.

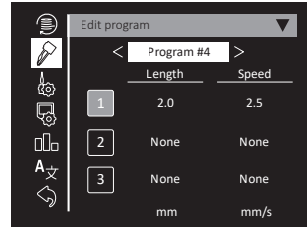
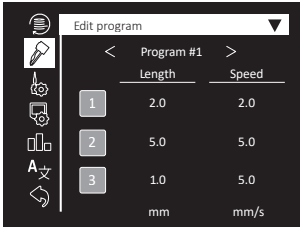

For each program, between 1 and 3 feeding steps (length and speed) should be defined. If fewer than 3 feeding steps are needed, set up wire length and speed to “0.0” and the parameter will change to “None”.

### Quick Access to Feeder Setting Modes

The solder wire dispensing values can be directly set up from the work screen.

Press or to change the tool temperature value.

When the main screen is displayed, speed and length values can be set up by pressing . The following parameters can be changed according to the different dispensing modes:

- Continuous Mode: Speed
- Discontinuous Mode: Speed and length
- Program Mode: 3 feeding parameter pairs (length and speed) for every program.

**Note:** First select the program to be modified at the work screen by using and to switch between the programs.



*Program number #*

# Control Process

## Menu Screen

Default PIN: 0105

### Main Menu

### Tin Reload Process

### Feeder Settings

### Counters

	Part	Tot
Plug hrs	28	
Working hrs	0	6
Sleep hrs	0	0
Hiber hrs	1	20
No tools hrs	1	2
Sleep cyc	20	24
Fed cyc	19	181
Fed mm	118	22786

\* partial and total counters are shown

### Tool Settings

### Language

### Station Settings

\*choose between mm and inches

## Accessories

### GALE Guide Kits for ALE250



References for GALE Guide Kits without Solder Wire Perforation

Solder Wire Ø range of use	Guide Kit Ref.	Guide Set Ref.	Outlet Nozzle Ref.	Nozzle Ref.	Traction Wheel Ref.	Support Wheel Ref.	Inlet Nozzle Ref.	Intern. Nozzle Ref.	Counter Wheel Ref.	Screw Ref.	Threaded Stud Ref.	Nozzle Grip Spring Ref.
0.38 - 0.40 mm 0.015 - 0.016 in	GALE04D-A	0028358	0025268	0021158	0019479	0020345	0019520	0024954	0026693	0026695 (x2)	0026696 (x3)	0030549
0.46 - 0.56 mm 0.018 - 0.022 in	GALE05D-A											
0.60 - 0.64 mm 0.023 - 0.025 in	GALE06D-A	0025270	0019170			0024956						
0.70 - 0.78 mm 0.028 - 0.031 in	GALE07D-A						0028359	0025272				
0.80 - 0.82 mm 0.032 - 0.033 in	GALE08D-A	0028360	0025274			0024958						
0.90 - 1.10 mm 0.036 - 0.044 in	GALE10D-A						0028361	0025276	26694			
1.14 - 1.27 mm 0.045 - 0.051 in	GALE12D-A	0028362	0024959									
1.50 - 1.57 mm 0.060 - 0.063 in	GALE15D-A					0028363	0024960					
1.60 - 1.63 mm 0.063 - 0.065 in	GALE16D-A	0028493	0021559									
1.80 mm 0.073 in	GALE18D-A											



References for GALE Guide Kits with Solder Wire Perforation

Solder Wire Ø range of use	Guide Kit Ref.	Guide Set Ref.	Outlet Nozzle Ref.	Nozzle Ref.	Guide Wheel Ref.	Blade Ref.	Blade Clamp Ref.	Inlet Nozzle Ref.	Intern. Nozzle Ref.	Counter Wheel Ref.	Screw Ref.	Threaded Stud Ref.	Nozzle Grip Spring Ref.
0.8 mm 0.032 in	GALE08V-A	0028358	0025270	0021158	0021696	0021555	0018638	0018632	0024955	0026693 (Supplied with ALE)	0026695 (x2)	0026696 (x3)	0030549
1.0 mm 0.040 in	GALE10V-A	0028359	0021560		0021699			0019170	0024956				
1.2 mm 0.047 in	GALE12V-A	0028360	0025272		0023738			0019171	0024957				
1.5 mm 0.059 in	GALE15V-A	0028361	0025274		0019696				0024958				
1.6 mm 0.063 in	GALE16V-A	0028363	0025276		0025922			0024233	0024959				

# Maintenance

Before carrying out maintenance, always switch the device off and disconnect it from the mains. Allow the equipment to cool down.

- Clean the station display with a glass cleaner or a damp cloth.
- Use a damp cloth to clean the casing and the tool. Alcohol can only be used to clean the metal parts.
- Periodically check that the metal parts of the tool and stand are clean so that the station can detect the tool's status.
- Maintain the tip surface clean and tinned prior to storage in order to avoid tip oxidation. Rusty and dirty surfaces reduce heat transfer to the solder joint.
- Periodically check all cables and tubes.
- Replace any defective or damaged pieces. Use only original JBC spare parts.
- Repairs should only be performed by a JBC authorized technical service.



- When this warning appears on the main screen, earthing fuse must be replaced.

- Replace a blown fuse as follows (applies to both the earthing fuse and the main fuse):

1. Pull off the fuse holder and remove the fuse. If necessary, use a tool to lever it off.
2. Insert the new fuse into the fuse holder and return it to the station.



Earthing Fuse

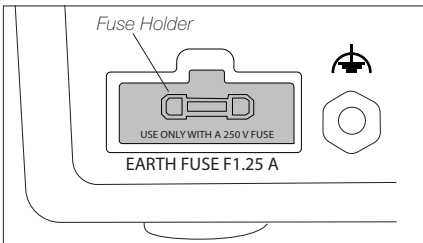

Main Fuse (below the control unit)

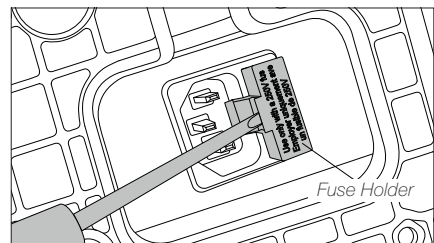



## Safety



**It is imperative to follow safety guidelines to prevent electric shock, injury, fire or explosion.**

- Do not use the units for any purpose other than soldering or rework. Incorrect use may cause a fire.
- The power cord must be plugged into approved bases. Be sure that it is properly grounded before use. When unplugging it, hold the plug, not the wire.
- Do not work on electrically live parts.
- The tool should be placed in the stand when not in use in order to activate the sleep mode. The soldering tip or nozzle, the metal part of the tool and the stand may still be hot even when the station is turned off. Handle with care, including when adjusting the stand position.
- Do not leave the appliance unattended when it is on.
- Do not cover the ventilation grills. Heat can cause inflammable products to ignite.
- Avoid flux coming into contact with skin or eyes to prevent irritation.
- Be careful with the fumes produced when soldering.
- Keep your workplace clean and tidy. Wear appropriate protection glasses and gloves when working to avoid personal harm.
- Utmost care must be taken with liquid tin waste which can cause burns.
- This appliance can be used by children over the age of eight and also people with reduced physical, sensory or mental capabilities or lack of experience provided that they have been given adequate supervision or instruction concerning the use of the appliance and understand the hazards involved. Children must not play with the appliance.
- Maintenance must not be carried out by children unless supervised.

# Specifications

## ALE

### Automatic-Feed Soldering Control Unit

#### With Solder Wire Perforation

for wire  $\varnothing$  0.8mm:

Ref. **ALE-908UVA** - 100V 50/60Hz. Input fuse: T2A. Earthing Fuse: F 1.25A. Output: 23.5V

Ref. **ALE-108UVA** - 120V 50/60Hz. Input fuse: T2A. Earthing Fuse: F 1.25A. Output: 23.5V

Ref. **ALE-208UVA** - 230V 50/60Hz. Input fuse: T1A. Earthing Fuse: F 1.25A. Output: 23.5V

for wire  $\varnothing$  1.0mm:

Ref. **ALE-910UVA** - 100V 50/60Hz. Input fuse: T2A. Earthing Fuse: F 1.25A. Output: 23.5V

Ref. **ALE-110UVA** - 120V 50/60Hz. Input fuse: T2A. Earthing Fuse: F 1.25A. Output: 23.5V

Ref. **ALE-210UVA** - 230V 50/60Hz. Input fuse: T1A. Earthing Fuse: F 1.25A. Output: 23.5V

for wire  $\varnothing$  1.2mm:

Ref. **ALE-912UVA** - 100V 50/60Hz. Input fuse: T2A. Earthing Fuse: F 1.25A. Output: 23.5V

Ref. **ALE-112UVA** - 120V 50/60Hz. Input fuse: T2A. Earthing Fuse: F 1.25A. Output: 23.5V

Ref. **ALE-212UVA** - 230V 50/60Hz. Input fuse: T1A. Earthing Fuse: F 1.25A. Output: 23.5V

for wire  $\varnothing$  1.5 mm:

Ref. **ALE-915UVA** - 100V 50/60Hz. Input fuse: T2A. Earthing Fuse: F 1.25A. Output: 23.5V

Ref. **ALE-115UVA** - 120V 50/60Hz. Input fuse: T2A. Earthing Fuse: F 1.25A. Output: 23.5V

Ref. **ALE-215UVA** - 230V 50/60Hz. Input fuse: T1A. Earthing Fuse: F 1.25A. Output: 23.5V

for wire  $\varnothing$  1.6 mm:

Ref. **ALE-916UVA** - 100V 50/60Hz. Input fuse: T2A. Earthing Fuse: F 1.25A. Output: 23.5V

Ref. **ALE-116UVA** - 120V 50/60Hz. Input fuse: T2A. Earthing Fuse: F 1.25A. Output: 23.5V

Ref. **ALE-216UVA** - 230V 50/60Hz. Input fuse: T1A. Earthing Fuse: F 1.25A. Output: 23.5V

#### Without Solder Wire Perforation

for wire  $\varnothing$  0.38 - 0.4 mm:

Ref. **ALE-904UA** - 100V 50/60Hz. Input fuse: T2A. Earthing Fuse: F 1.25A. Output: 23.5V

Ref. **ALE-104UA** - 120V 50/60Hz. Input fuse: T2A. Earthing Fuse: F 1.25A. Output: 23.5V

Ref. **ALE-204UA** - 230V 50/60Hz. Input fuse: T1A. Earthing Fuse: F 1.25A. Output: 23.5V

for wire  $\varnothing$  0.45 - 0.56 mm:

Ref. **ALE-905UA** - 100V 50/60Hz. Input fuse: T2A. Earthing Fuse: F 1.25A. Output: 23.5V

Ref. **ALE-105UA** - 120V 50/60Hz. Input fuse: T2A. Earthing Fuse: F 1.25A. Output: 23.5V

Ref. **ALE-205UA** - 230V 50/60Hz. Input fuse: T1A. Earthing Fuse: F 1.25A. Output: 23.5V

for wire  $\varnothing$  0.60 - 0.64 mm:

Ref. **ALE-906UA** - 100V 50/60Hz. Input fuse: T2A. Earthing Fuse: F 1.25A. Output: 23.5V

Ref. **ALE-106UA** - 120V 50/60Hz. Input fuse: T2A. Earthing Fuse: F 1.25A. Output: 23.5V

Ref. **ALE-206UA** - 230V 50/60Hz. Input fuse: T1A. Earthing Fuse: F 1.25A. Output: 23.5V

for wire  $\varnothing$  0.70 - 0.78 mm:

Ref. **ALE-907UA** - 100V 50/60Hz. Input fuse: T2A. Earthing Fuse: F 1.25A. Output: 23.5V

Ref. **ALE-107UA** - 120V 50/60Hz. Input fuse: T2A. Earthing Fuse: F 1.25A. Output: 23.5V

Ref. **ALE-207UA** - 230V 50/60Hz. Input fuse: T1A. Earthing Fuse: F 1.25A. Output: 23.5V

## Specifications

**Without** Solder Wire Perforation

for wire Ø 0.80 - 0.82 mm:

- Ref. **ALE-908UA** - 100V 50/60Hz. Input fuse: T2A. Earthing Fuse: F 1.25A. Output: 23.5V
- Ref. **ALE-108UA** - 120V 50/60Hz. Input fuse: T2A. Earthing Fuse: F 1.25A. Output: 23.5V
- Ref. **ALE-208UA** - 230V 50/60Hz. Input fuse: T1A. Earthing Fuse: F 1.25A. Output: 23.5V

for wire ø 0.90 - 1.10 mm:

- Ref. **ALE-910UA** - 100V 50/60Hz. Input fuse: T2A. Earthing Fuse: F 1.25A. Output: 23.5V
- Ref. **ALE-110UA** - 120V 50/60Hz. Input fuse: T2A. Earthing Fuse: F 1.25A. Output: 23.5V
- Ref. **ALE-210UA** - 230V 50/60Hz. Input fuse: T1A. Earthing Fuse: F 1.25A. Output: 23.5V

for wire Ø 1.14 - 1.27 mm:

- Ref. **ALE-912UA** - 100V 50/60Hz. Input fuse: T2A. Earthing Fuse: F 1.25A. Output: 23.5V
- Ref. **ALE-112UA** - 120V 50/60Hz. Input fuse: T2A. Earthing Fuse: F 1.25A. Output: 23.5V
- Ref. **ALE-212UA** - 230V 50/60Hz. Input fuse: T1A. Earthing Fuse: F 1.25A. Output: 23.5V

for wire Ø 1.50 - 1.57 mm:

- Ref. **ALE-915UA** - 100V 50/60Hz. Input fuse: T2A. Earthing Fuse: F 1.25A. Output: 23.5V
- Ref. **ALE-115UA** - 120V 50/60Hz. Input fuse: T2A. Earthing Fuse: F 1.25A. Output: 23.5V
- Ref. **ALE-215UA** - 230V 50/60Hz. Input fuse: T1A. Earthing Fuse: F 1.25A. Output: 23.5V

for wire Ø 1.60 - 1.63 mm:

- Ref. **ALE-916UA** - 100V 50/60Hz. Input fuse: T2A. Earthing Fuse: F 1.25A. Output: 23.5V
- Ref. **ALE-116UA** - 120V 50/60Hz. Input fuse: T2A. Earthing Fuse: F 1.25A. Output: 23.5V
- Ref. **ALE-216UA** - 230V 50/60Hz. Input fuse: T1A. Earthing Fuse: F 1.25A. Output: 23.5V

for wire Ø 1.80 mm:

- Ref. **ALE-918UA** - 100V 50/60Hz. Input fuse: T2A. Earthing Fuse: F 1.25A. Output: 23.5V
- Ref. **ALE-118UA** - 120V 50/60Hz. Input fuse: T2A. Earthing Fuse: F 1.25A. Output: 23.5V
- Ref. **ALE-218UA** - 230V 50/60Hz. Input fuse: T1A. Earthing Fuse: F 1.25A. Output: 23.5V

- Nominal Power: 180 W
- Peak Power (Tool): 150 W
- Selectable Temperature: 90 - 450 °C / 190 - 840 °F
- Idle Temp. Stability (still air): ±1.5°C / ±3°F (Meets and exceeds IPC J-STD-001)
- Temp. Accuracy: ±3% (Using reference cartridge)
- Temp. Adjustment: ±50°C / ±90°F (Through station menu settings)
- Connections: USB-A Update and files import-export  
USB-B Software PC  
RJ12 Fume extractor connection
- Equipontencial bonding: Optional connection to EPA
- Tip to Ground Voltage/Resistance: <2 mV RMS / <2 ohms  
Meets and exceeds  
ANSI/ESD S20.20-2014 / IPC J-STD-001F
- Solder Wire Diameter: According to purchased reference
- Max. Wire Length: 250 mm / 9.84 in (for discontinuous + program mode)
- Min. Wire Length: 0.5 mm / 0.02 in
- Forward Speed Range: 0.5 to 50 mm/s / 0.02 to 1.97 in/s
- Speed of Backward Function: 0.0 to 5.0 mm/s / 0.5 to 0.20 in/s

More data on the next page.

# Specifications

- |   |  |
|---|--|
| - Number of Programs:                         | 5 Programs   |
| - Number of Program Steps:                    | 1 to 3 Steps (for each program)                                    |
| - Control Unit Dimensions:<br>(L x W x H)     | 235 x 145 x 150 mm<br>9.25 x 5.71 x 5.91 in                        |
| - Total Net Weight:                           | 5.81 kg / 12.81 lb   |
| - Package Dimensions / Weight:<br>(L x W x H) | 368 x 368 x 195 mm / 6.72 Kg<br>14.49 x 14.49 x 7.68 in / 14.82 lb |

## Compatible Solder Reel:

- |                       |                      |
|-----------------------|----------------------|
| - Reel Weight:        | Up to 2 kg / 4.41 lb |
| - Max. Reel Diameter: | 100 mm / 3.94 in     |
| - Max. Reel Height:   | 100 mm / 3.94 in     |

Complies with CE standards.  
ESD safe.

# JBC

## Warranty

JBC's 2 year warranty covers this equipment against all manufacturing defects, including the replacement of defective parts and labour.

Warranty does not cover product wear or misuse.

In order for the warranty to be valid, equipment must be returned, postage paid, to the dealer where it was purchased.

**Get 1 extra year JBC warranty by registering here:**  
<https://www.jbctools.com/productregistration/>  
**within 30 days of purchase.**



This product should not be thrown in the garbage.

In accordance with the European directive 2012/19/EU, electronic equipment at the end of its life must be collected and returned to an authorized recycling facility.

**CE EAC UK  
CA**

[www.jbctools.com](http://www.jbctools.com)

0030217-061023